

EXPLODED DRAWING A

Model No. PFTL39920-INT.0 R0421A

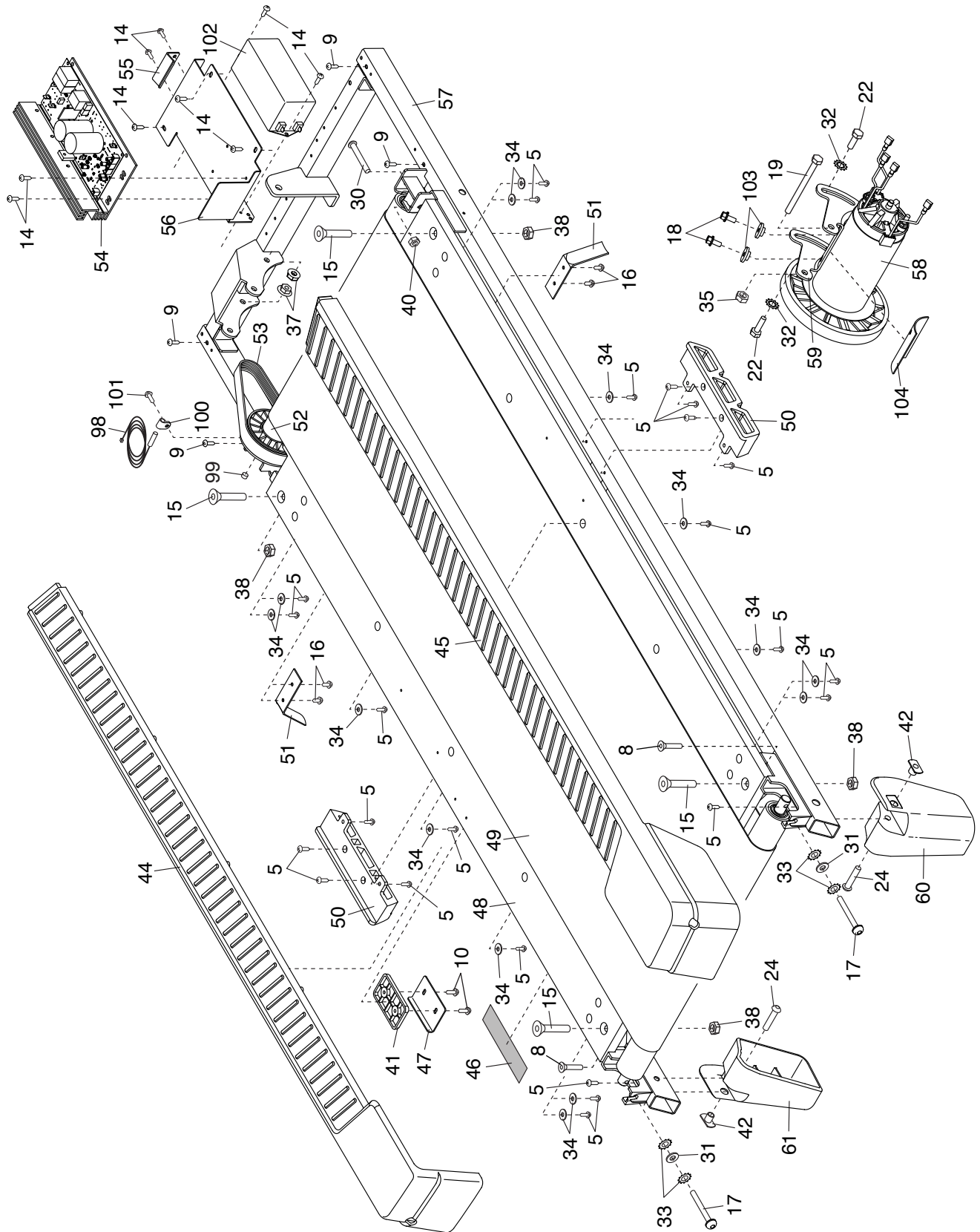

EXPLODED DRAWING B

Model No. PFTL39920-INT.0 R0421A

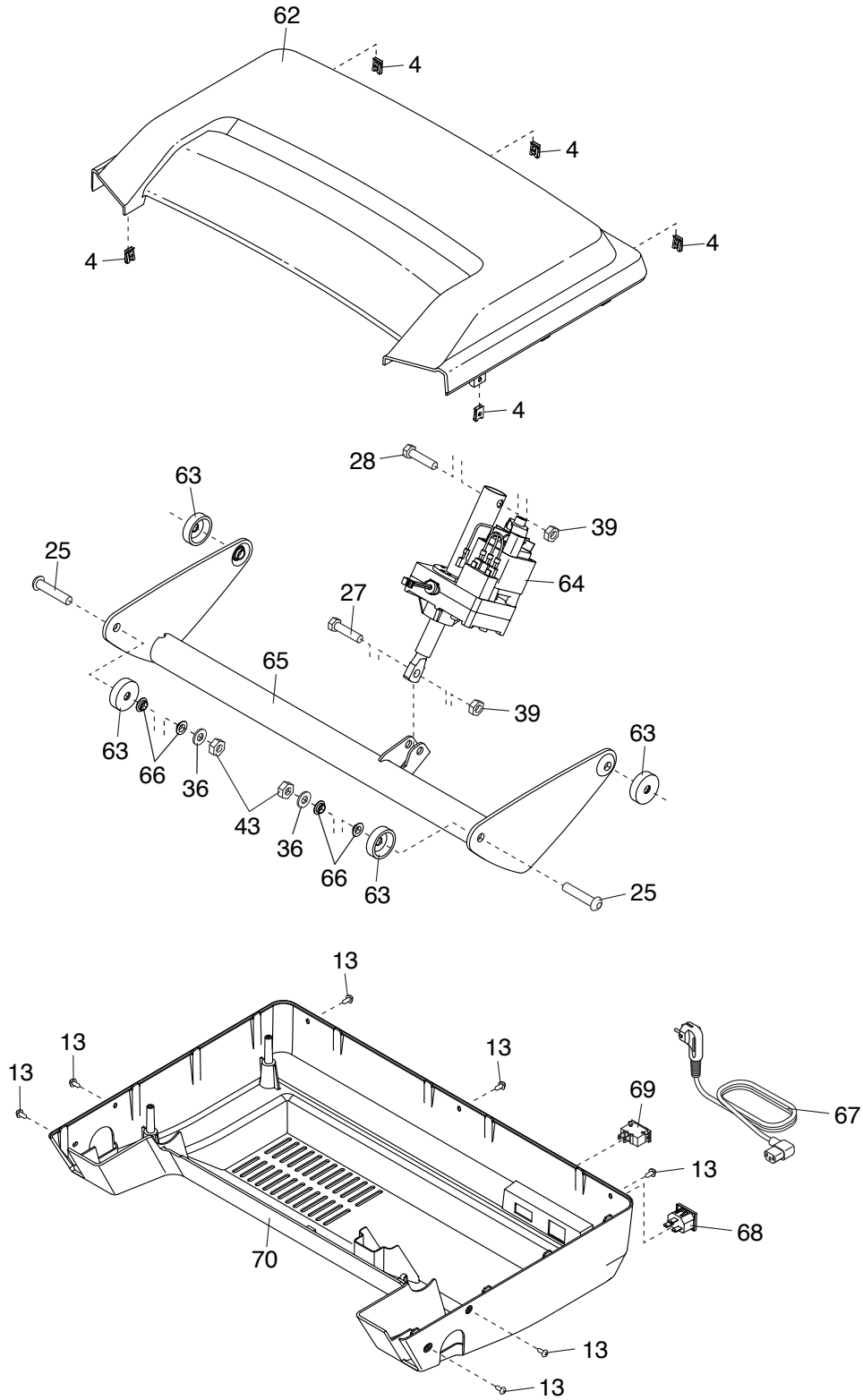

EXPLODED DRAWING C

Model No. PFTL39920-INT.0 R0421A

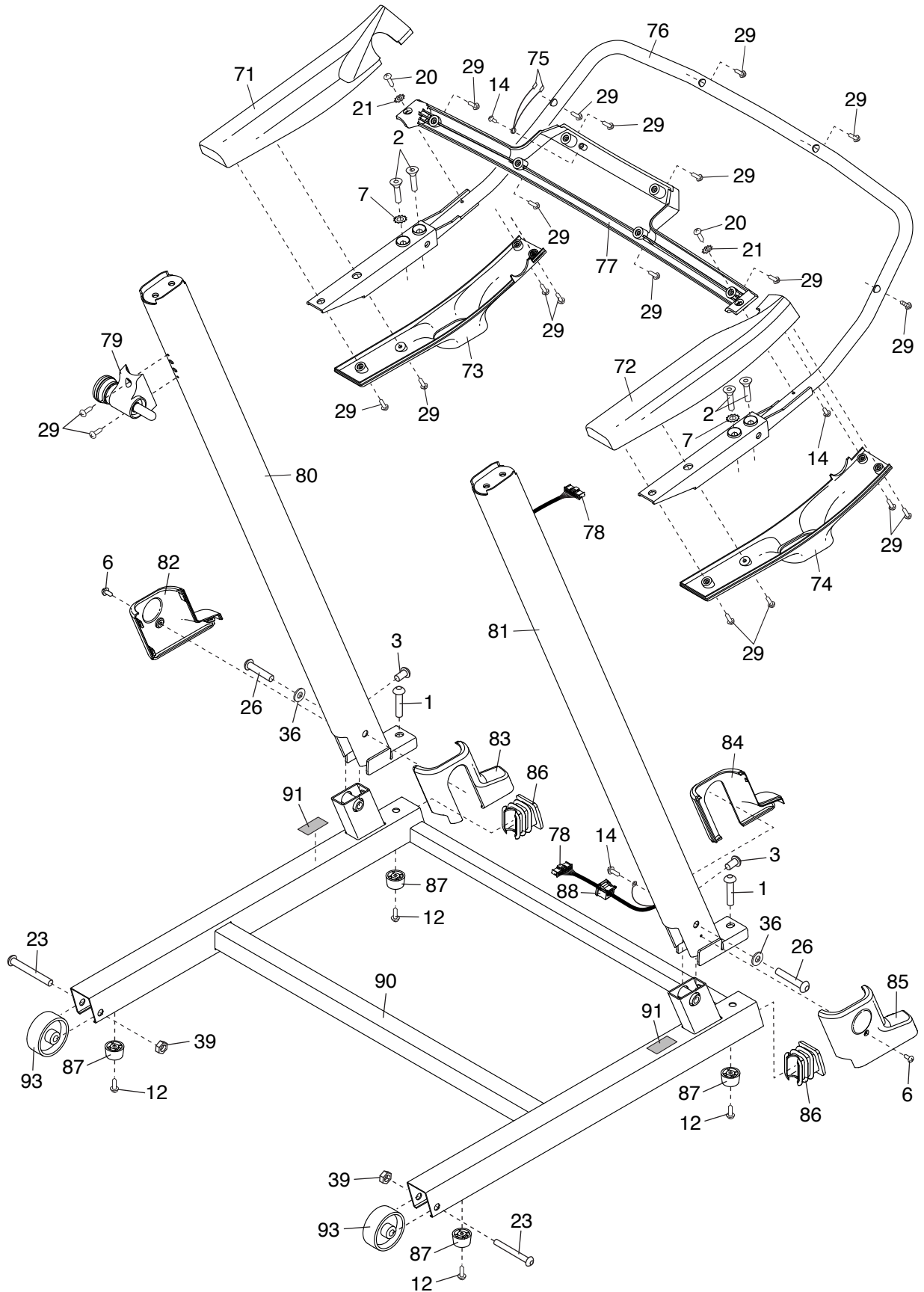

EXPLODED DRAWING D

Model No. PFTL39920-INT.0 R0421A

